



"Together we enjoy, aspire, create & achieve"

Maths Key Skills
Optional Summer Booklet

2021

Content

Page 3: Multiplication (Grid Method)

Page 4: Multiplication (Column Method)

Page 5: Multiplication of Decimals

Page 6: Short Division

Page 7: Division of and by Decimals

Page 8: Fraction Addition and Subtraction

Page 9: Fraction Multiplication and Division

Page 10: Fraction of an Amount

Page 11: Calculating with Negative Numbers

Page 12: Ratio of an amount

Page 13: Area – Quadrilaterals

Page 14: Area – Triangles and Circles

Grid Method Multiplication

1)

×	3	5
2		
8		

2)

×	6	8
4		
5		

3)

×	7	5
6		
1		

4)

×	12	3
5		
6		

5)

×	4	7
11		
4		

6)

×	10	3
7		
9		

7)

×	5	6
4		
2		

8)

×	8	9
6		
7		

9)

×	12	11
10		
9		

1)

×	2	5	7
6			
3			
12			

2)

×	8	7	4
5			
2			
9			

3)

×	8	0	4
7			
5			
2			

4)

×	11	8	9
12			
7			
6			

Can you work out the missing numbers and then complete the multiplication?

1)

×			4
6			24
7	21	35	
		25	

2)

×		4	
5			
3		12	18
	96		72

3)

×			
	48		
	42	56	63
	12		

4)

×			
		33	
	42	66	72
		132	

Column Method Multiplication

$$\begin{array}{r} 52 \\ \times 14 \\ \hline \end{array}$$

$$\begin{array}{r} 89 \\ \times 14 \\ \hline \end{array}$$

$$\begin{array}{r} 72 \\ \times 15 \\ \hline \end{array}$$

$$\begin{array}{r} 82 \\ \times 14 \\ \hline \end{array}$$

$$\begin{array}{r} 67 \\ \times 13 \\ \hline \end{array}$$

$$\begin{array}{r} 356 \\ \times 15 \\ \hline \end{array}$$

$$\begin{array}{r} 506 \\ \times 17 \\ \hline \end{array}$$

$$\begin{array}{r} 762 \\ \times 18 \\ \hline \end{array}$$

$$\begin{array}{r} 458 \\ \times 16 \\ \hline \end{array}$$

$$\begin{array}{r} 698 \\ \times 14 \\ \hline \end{array}$$

$$\begin{array}{r} 724 \\ \times 18 \\ \hline \end{array}$$

$$\begin{array}{r} 218 \\ \times 19 \\ \hline \end{array}$$

$$\begin{array}{r} 954 \\ \times 13 \\ \hline \end{array}$$

$$\begin{array}{r} 966 \\ \times 14 \\ \hline \end{array}$$

$$\begin{array}{r} 136 \\ \times 17 \\ \hline \end{array}$$

$$\begin{array}{r} 69 \\ \times 79 \\ \hline \end{array}$$

$$\begin{array}{r} 78 \\ \times 45 \\ \hline \end{array}$$

$$\begin{array}{r} 86 \\ \times 27 \\ \hline \end{array}$$

$$\begin{array}{r} 91 \\ \times 46 \\ \hline \end{array}$$

$$\begin{array}{r} 91 \\ \times 36 \\ \hline \end{array}$$

$$\begin{array}{r} 294 \\ \times 45 \\ \hline \end{array}$$

$$\begin{array}{r} 145 \\ \times 36 \\ \hline \end{array}$$

$$\begin{array}{r} 934 \\ \times 42 \\ \hline \end{array}$$

$$\begin{array}{r} 742 \\ \times 20 \\ \hline \end{array}$$

$$\begin{array}{r} 457 \\ \times 33 \\ \hline \end{array}$$

$$\begin{array}{r} 563 \\ \times 99 \\ \hline \end{array}$$

$$\begin{array}{r} 451 \\ \times 83 \\ \hline \end{array}$$

$$\begin{array}{r} 892 \\ \times 78 \\ \hline \end{array}$$

$$\begin{array}{r} 456 \\ \times 89 \\ \hline \end{array}$$

$$\begin{array}{r} 234 \\ \times 67 \\ \hline \end{array}$$

Multiplication of Decimals

1) $3 \times 0.4 =$

2) $9 \times 0.7 =$

3) $8 \times 0.2 =$

4) $0.6 \times 4 =$

5) $4 \times 1.9 =$

6) $5 \times 2.7 =$

7) $6 \times 3.8 =$

8) $9.3 \times 2 =$

9) $7 \times 16.2 =$

10) $13.9 \times 8 =$

11) $4 \times 57.4 =$

12) $36.4 \times 7 =$

1) $6 \times 0.04 =$

2) $0.9 \times 0.7 =$

3) $0.8 \times 0.03 =$

4) $0.09 \times 0.2 =$

5) $3 \times 8.42 =$

6) $1.904 \times 6 =$

7) $1.4 \times 9.6 =$

8) $7.7 \times 0.15 =$

9) $9.53 \times 7.4 =$

Short Division

1) $2 \overline{) 12}$

2) $3 \overline{) 18}$

3) $5 \overline{) 15}$

4) $4 \overline{) 16}$

5) $4 \overline{) 28}$

6) $3 \overline{) 27}$

7) $6 \overline{) 24}$

8) $7 \overline{) 21}$

9) $5 \overline{) 45}$

10) $7 \overline{) 56}$

11) $6 \overline{) 42}$

12) $8 \overline{) 72}$

13) $9 \overline{) 54}$

14) $5 \overline{) 20}$

15) $8 \overline{) 48}$

16) $4 \overline{) 24}$

Try these more challenging numbers:

1) $2 \overline{) 1464}$

2) $3 \overline{) 2169}$

3) $4 \overline{) 3204}$

4) $3 \overline{) 1506}$

5) $7 \overline{) 2156}$

6) $4 \overline{) 3656}$

7) $5 \overline{) 4850}$

8) $6 \overline{) 1986}$

9) $2 \overline{) 1554}$

10) $9 \overline{) 7866}$

11) $8 \overline{) 5360}$

12) $7 \overline{) 4928}$

13) $6 \overline{) 5772}$

14) $3 \overline{) 2865}$

15) $4 \overline{) 3300}$

16) $5 \overline{) 1880}$

Set up your own bus stop calculation for the following questions:

1) $75 \div 3 =$

2) $68 \div 4 =$

3) $84 \div 6 =$

4) $95 \div 5 =$

5) $74 \div 2 =$

6) $732 \div 3 =$

7) $504 \div 4 =$

8) $384 \div 6 =$

9) $475 \div 5 =$

10) $904 \div 2 =$

11) $9051 \div 7 =$

12) $1704 \div 8 =$

13) $5136 \div 2 =$

14) $9483 \div 3 =$

15) $7620 \div 4 =$

Division of Decimals

1) $3 \overline{) 60.3}$

5) $3 \overline{) 816.3}$

9) $2 \overline{) 105.07}$

2) $2 \overline{) 31.2}$

6) $9 \overline{) 132.3}$

10) $4 \overline{) 120.16}$

3) $5 \overline{) 99.5}$

7) $5 \overline{) 62.135}$

11) $6 \overline{) 3420.6}$

4) $9 \overline{) 86.58}$

8) $4 \overline{) 314.16}$

12) $8 \overline{) 1.000}$

Division by decimals. Remember to convert to an integer as we cannot divide by decimals

1) $24 \div 0.8 =$

5) $1.5 \div 0.5 =$

9) $0.12 \div 0.2 =$

2) $36 \div 0.6 =$

6) $2.2 \div 0.2 =$

10) $0.63 \div 0.7 =$

3) $210 \div 0.3 =$

7) $4.8 \div 0.4 =$

11) $0.16 \div 0.4 =$

4) $1080 \div 0.9 =$

8) $5.6 \div 0.7 =$

12) $0.02 \div 0.5 =$

1) $40 \div 0.04 =$

5) $0.54 \div 0.06 =$

9) $4.5 \div 0.15 =$

2) $33 \div 0.03 =$

6) $0.16 \div 0.02 =$

10) $12.5 \div 0.25 =$

3) $320 \div 0.08 =$

7) $2.7 \div 0.09 =$

11) $7.8 \div 0.13 =$

4) $1210 \div 0.11 =$

8) $8.4 \div 0.12 =$

12) $54 \div 0.018 =$

Addition and Subtraction of Fractions.

Remember to make the denominators the same

1) $\frac{1}{8} + \frac{1}{2}$

4) $\frac{1}{5} - \frac{1}{15}$

7) $\frac{1}{5} + \frac{1}{4}$

10) $\frac{1}{12} + \frac{1}{5}$

2) $\frac{1}{20} + \frac{2}{5}$

5) $\frac{1}{40} + \frac{1}{2}$

8) $\frac{1}{7} - \frac{1}{11}$

11) $\frac{1}{5} + \frac{1}{8}$

3) $\frac{1}{7} - \frac{1}{14}$

6) $\frac{1}{2} - \frac{1}{3}$

9) $\frac{1}{15} + \frac{1}{2}$

12) $\frac{1}{9} - \frac{1}{10}$

You can leave your answer as an improper fraction

1) $\frac{1}{15} + \frac{2}{5}$

4) $\frac{1}{2} - \frac{7}{16}$

7) $\frac{3}{7} - \frac{2}{5}$

10) $\frac{3}{10} + \frac{6}{7}$

2) $\frac{2}{3} - \frac{1}{21}$

5) $\frac{3}{5} + \frac{1}{2}$

8) $\frac{7}{11} + \frac{2}{3}$

11) $\frac{7}{9} + \frac{3}{8}$

3) $\frac{1}{4} + \frac{5}{12}$

6) $\frac{1}{6} + \frac{9}{10}$

9) $\frac{4}{5} - \frac{5}{8}$

12) $\frac{3}{4} - \frac{6}{15}$

Fraction Multiplication

1) $\frac{2}{5} \times \frac{3}{7}$

3) $\frac{2}{7} \times \frac{2}{9}$

5) $\frac{3}{8} \times \frac{7}{12}$

7) $\frac{4}{5} \times \frac{3}{6}$

9) $\frac{5}{11} \times \frac{3}{5}$

2) $\frac{4}{5} \times \frac{3}{10}$

4) $\frac{2}{9} \times \frac{6}{11}$

6) $\frac{10}{12} \times \frac{7}{8}$

8) $\frac{6}{12} \times \frac{3}{8}$

10) $\frac{21}{100} \times \frac{2}{50}$

Remember if there is an integer involved you make this a fraction by putting a denominator of 1, then calculate as above

1) $\frac{1}{4} \times 2$

3) $\frac{3}{7} \times 5$

5) $\frac{7}{8} \times 10$

7) $3 \times \frac{7}{9}$

9) $5 \times \frac{9}{20}$

2) $\frac{1}{5} \times 3$

4) $\frac{5}{7} \times 3$

6) $\frac{3}{5} \times 4$

8) $8 \times \frac{3}{12}$

10) $12 \times \frac{11}{100}$

Fraction Division

1) $\frac{5}{7} \div 4$

3) $\frac{12}{11} \div 8$

5) $5 \div \frac{2}{7}$

7) $\frac{3}{8} \div \frac{2}{5}$

9) $\frac{10}{3} \div \frac{5}{11}$

2) $\frac{9}{4} \div 7$

4) $9 \div \frac{1}{3}$

6) $\frac{7}{3} \div \frac{4}{3}$

8) $\frac{5}{2} \div \frac{3}{7}$

10) $\frac{7}{12} \div \frac{8}{9}$

Fraction of an amount

1) $\frac{1}{2}$ of 12 =

5) $\frac{1}{4}$ of 16 =

9) $\frac{1}{8}$ of 16 =

2) $\frac{1}{2}$ of 14 =

6) $\frac{1}{4}$ of 20 =

10) $\frac{1}{6}$ of 72 =

3) $\frac{1}{3}$ of 18 =

7) $\frac{1}{5}$ of 15 =

11) $\frac{1}{11}$ of 121 =

4) $\frac{1}{3}$ of 27 =

8) $\frac{1}{5}$ of 25 =

12) $\frac{1}{20}$ of 80 =

1) $\frac{1}{2}$ of = 36

6) $\frac{1}{\text{input}}$ of 46 = 23

2) $\frac{1}{3}$ of = 18

7) $\frac{1}{\text{input}}$ of 65 = 13

3) $\frac{1}{5}$ of = 25

8) $\frac{1}{\text{input}}$ of 84 = 21

4) $\frac{1}{6}$ of = 14

9) $\frac{1}{\text{input}}$ of 96 = 16

5) $\frac{1}{4}$ of = 75

10) $\frac{1}{\text{input}}$ of 105 = 15

1) $\frac{2}{3}$ of 12 =

5) $\frac{5}{12}$ of 240 =

9) $\frac{\text{input}}{12}$ of 360 = 210

2) $\frac{3}{7}$ of 14 =

6) $\frac{4}{9}$ of 108 =

10) $\frac{\text{input}}{50}$ of 1000 = 220

3) $\frac{5}{6}$ of 18 =

7) $\frac{7}{15}$ of 600 =

11) $\frac{5}{\text{input}}$ of 16 = 10

4) $\frac{3}{8}$ of 24 =

8) $\frac{17}{51}$ of 102 =

12) $\frac{4}{\text{input}}$ of 72 = 32

Addition and Subtraction with Negative Numbers

- 1) $2 - 7 =$
- 2) $-4 + 8 =$
- 3) $-2 + 12 =$
- 4) $-7 - 4 =$
- 5) $9 - 10 =$
- 6) $-7 + 4 =$

- 7) $-8 - 11 =$
- 8) $-15 + 1 =$
- 9) $-12 + 14 =$
- 10) $-10 + 23 =$
- 11) $-6 - 11 =$
- 12) $-12 - 17 =$

- 1) $-8 - -12 =$
- 2) $-8 + -10 =$
- 3) $-16 - +7 =$
- 4) $27 + -5 =$
- 5) $-17 - -3 =$
- 6) $-3 - -14 =$

- 7) $-17 + -9 =$
- 8) $-8 - +19 =$
- 9) $-54 - +24 =$
- 10) $-10 - -8 =$
- 11) $9 - +20 =$
- 12) $-18 - -33 =$

Multiplication

×	8	-3	7	-4
5	40			
-6		18		
4				-16
-11				-77

×	-7	3	1	-4
-2				
8				
-9				
10				

×	-5	4	-9	2
-2				
-3				
-7				
6				

×	7	-9	4	-3
1				
6				
-5				
-8				

×	8	-2	-7	9
12				
-5				
-11				
-8				

×	-5	4	-9	2
-2				
-3				
-7				
6				

Ratio of an Amount – 2 parts

- (a) Share £104 in the ratio 3:5
- (b) Divide 161 miles in the ratio 6:1
- (c) Divide 315ml in the ratio 2:7
- (d) Share \$650 in the ratio 4:9
- (e) Share £800 in the ratio 11:14
- (f) Share 1200kg in the ratio 3:37
- (g) Divide €510 in the ratio 13:2
- (h) Share 1116mm in the ratio 1:8

Ratio of an Amount – More than 2 parts

- (a) Share £40 in the ratio 1:3:4
- (b) Divide 63ml in the ratio 2:3:4
- (c) Share 88p in the ratio 2:4:5
- (d) Share 180° in the ratio 2:2:5
- (e) Divide \$165 in the ratio 1:2:12
- (f) Share 720cm in the ratio 3:4:2:9

Area of Quadrilaterals

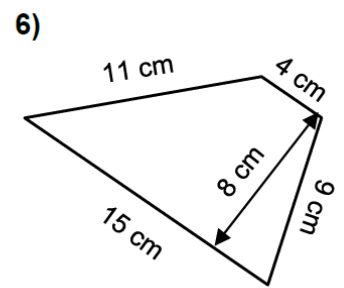
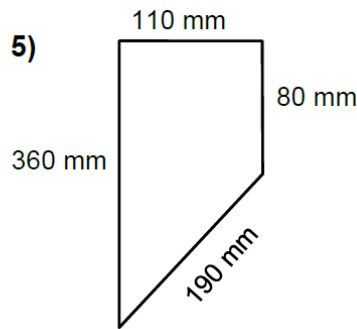
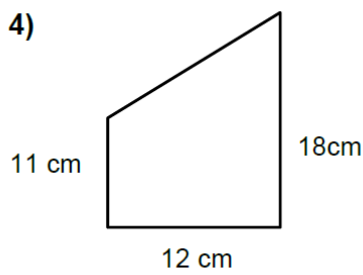
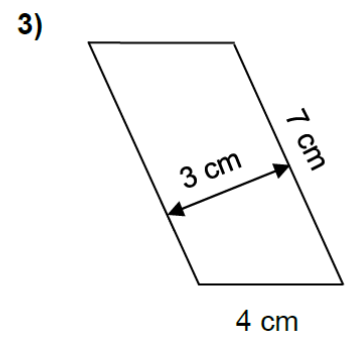
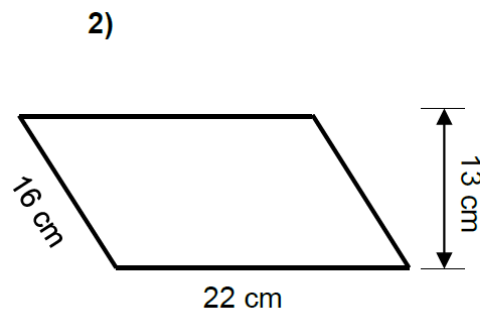
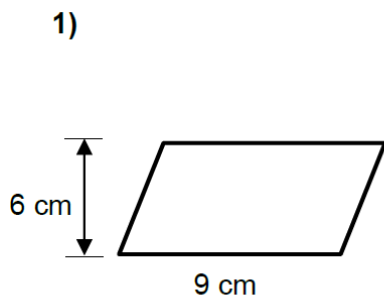
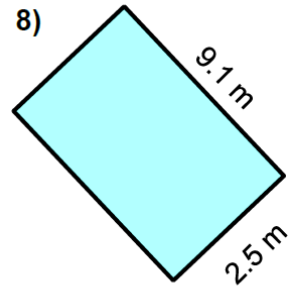
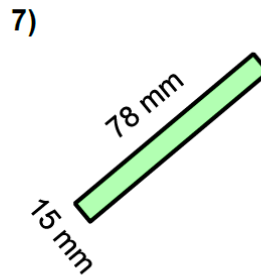
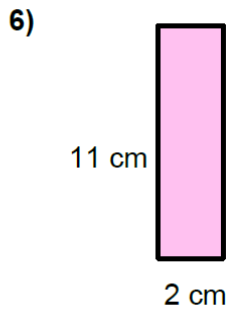
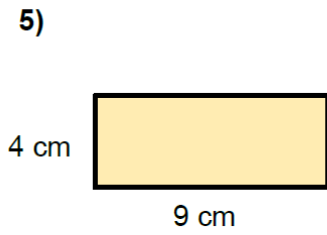
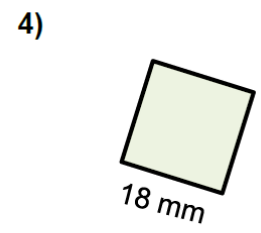
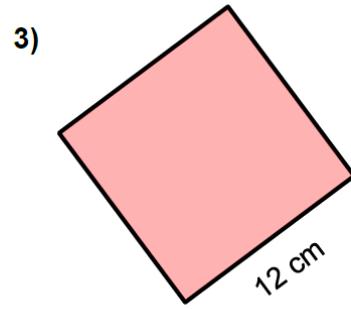
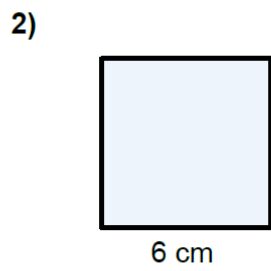
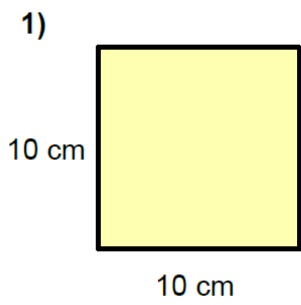

Area of Triangles and Circles

